



# RAILHEAD

**SQUARE BAR**



SP110 ~ 10 x 10mm  
SP162 ~ 12 x 12mm  
SP166 ~ 16 x 16mm  
SP160 ~ 20 x 20mm  
SP25 ~ 25 x 25mm

**ROUND BAR**

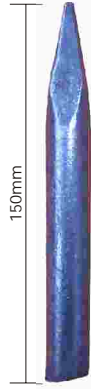

SR110 ~ 10mm  
SR162 ~ 12mm  
SR166 ~ 16mm  
SR160 ~ 20mm  
SR25 ~ 25mm

**SQUARE BAR**



LF110 ~ 10 x 10mm  
LF162 ~ 12 x 12mm  
LF166 ~ 16 x 16mm  
LF160 ~ 20 x 20mm  
LF25 ~ 25 x 25mm

**ROUND BAR**

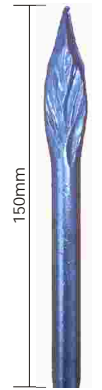

LR110 ~ 10mm  
LR162 ~ 12mm  
LR166 ~ 16mm  
LR160 ~ 20mm  
LR25 ~ 25mm

**SQUARE BAR**



LFB162 ~ 12 x 12mm  
LFB166 ~ 16 x 16mm  
LFB160 ~ 20 x 20mm  
LFB25 ~ 25 x 25mm

**ROUND BAR**

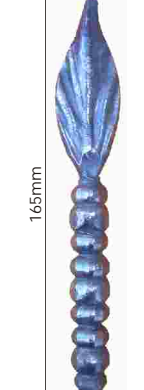

LRB162 ~ 12mm  
LRB166 ~ 16mm  
LRB160 ~ 20mm  
LRB25 ~ 25mm

**SQUARE BAR**



SPB162 ~ 12 x 12mm  
SPB166 ~ 16 x 16mm  
SPB160 ~ 20 x 20mm  
SPB25 ~ 25 x 25mm

**ROUND BAR**

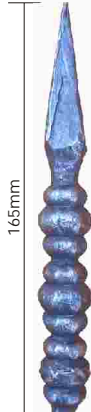

SRB162 ~ 12mm  
SRB166 ~ 16mm  
SRB160 ~ 20mm  
SRB25 ~ 25mm

**SQUARE BAR**

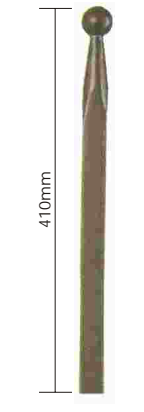

BS011 ~ 12 x 12mm  
BS012 ~ 16 x 16mm

**ROUND BAR**



BS015 ~ 12mm  
BS016 ~ 16mm

**SQUARE BAR**

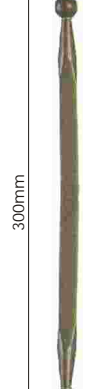

BS1011 ~ 12 x 12mm  
BS1012 ~ 16 x 16mm

**ROUND BAR**

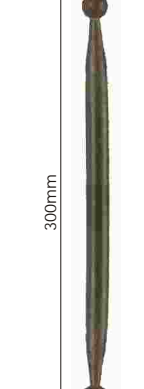

BS1015 ~ 12mm  
BS1016 ~ 16mm

Reproduction Prohibited

**IMPORTANT**

IMAGES ARE ILLUSTRATIVE ONLY, ALL SIZES APPROXIMATE AS VARIATIONS MAY OCCUR.  
SEE REFERENCE PAGE.

# RAILHEAD

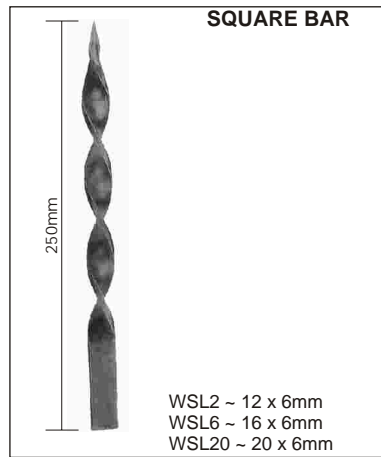
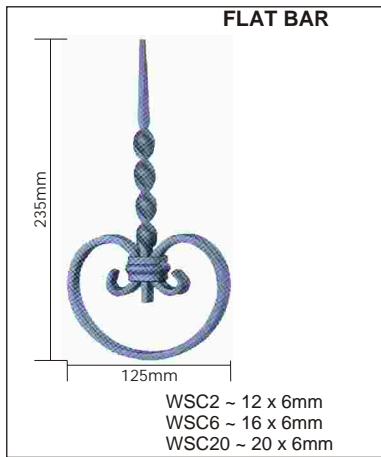
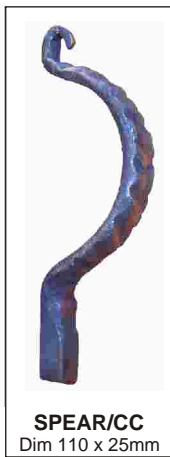
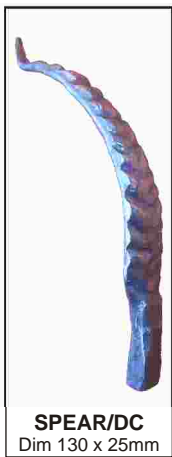
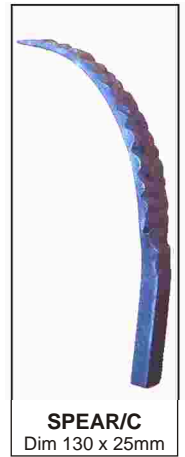
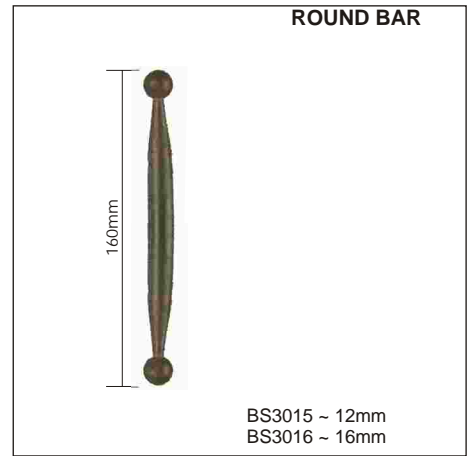
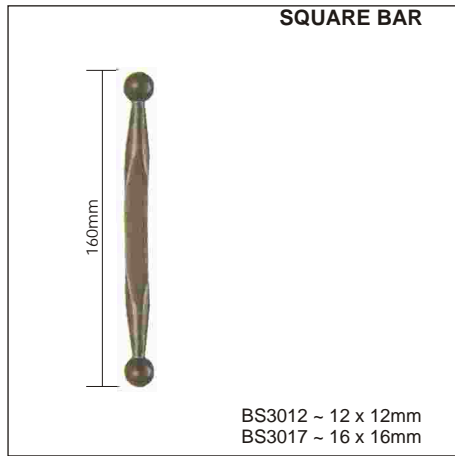
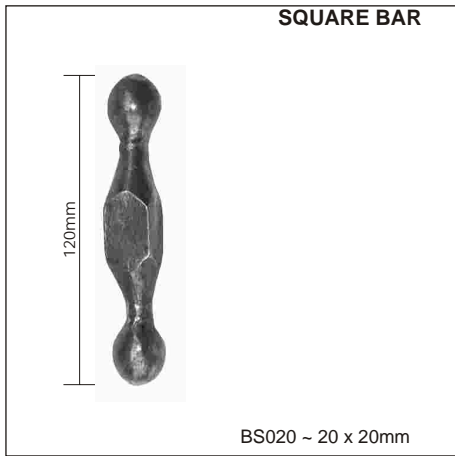
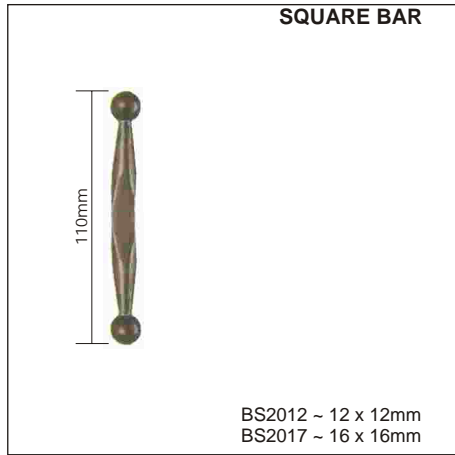
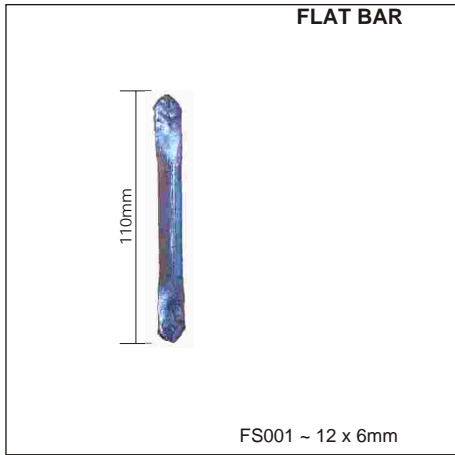

**IMPORTANT**

IMAGES ARE ILLUSTRATIVE ONLY, ALL SIZES APPROXIMATE AS VARIATIONS MAY OCCUR. SEE REFERENCE PAGE.



# RAILHEAD

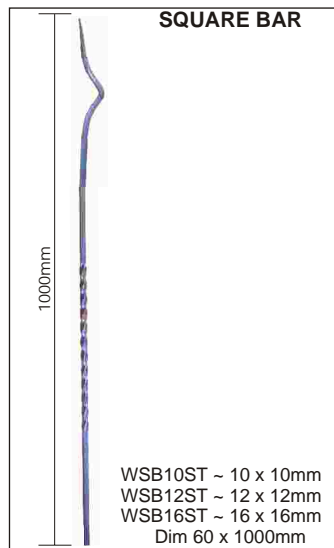
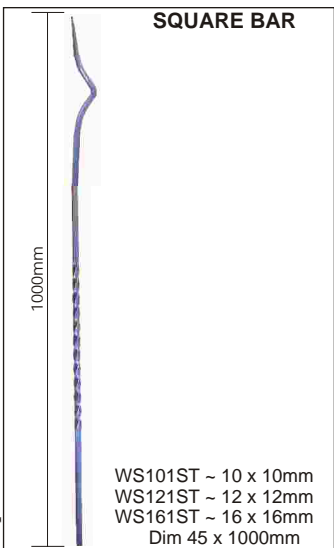
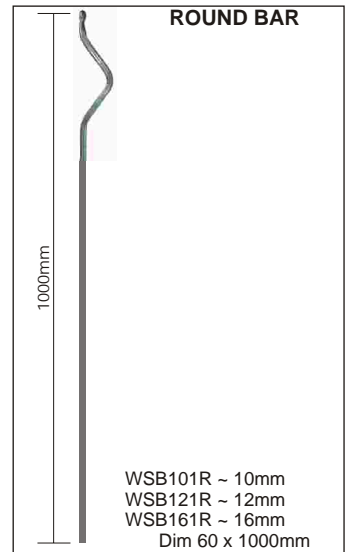
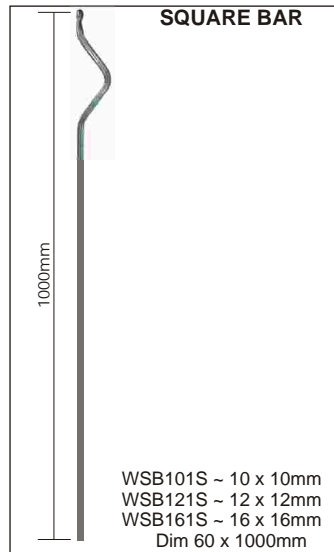
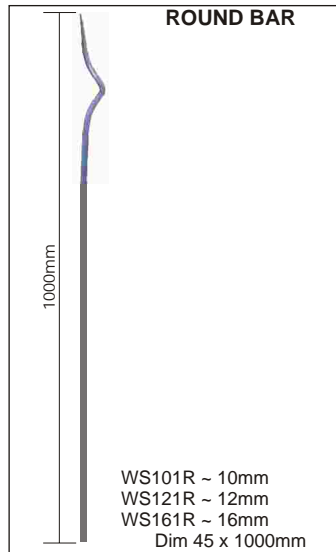
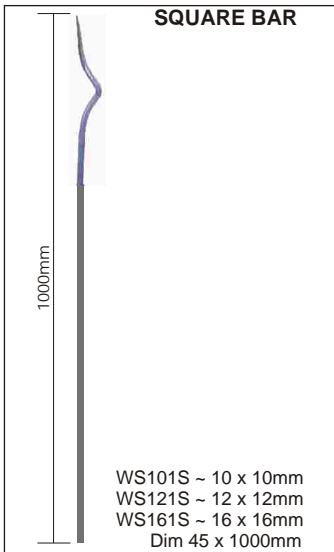
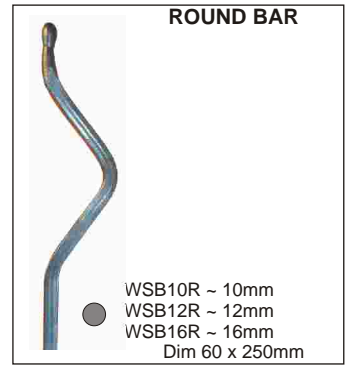
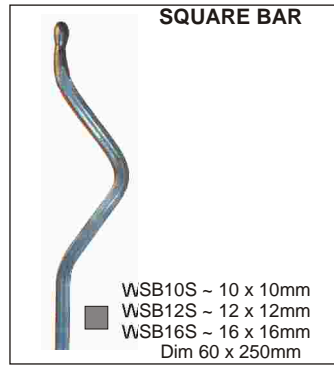
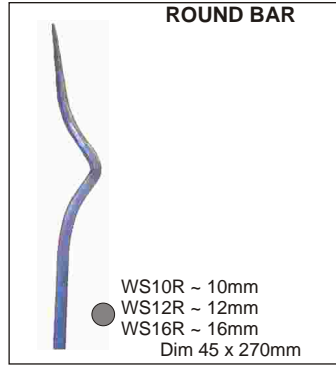
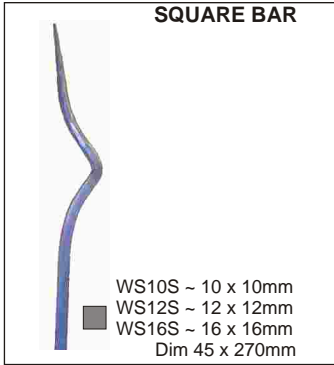
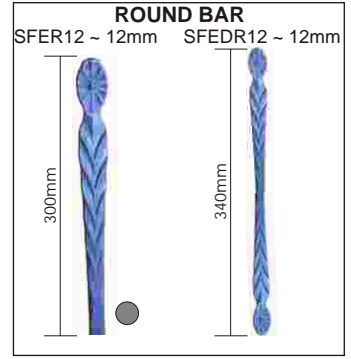
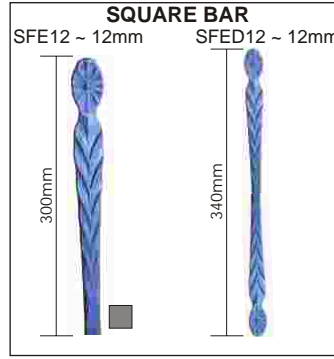
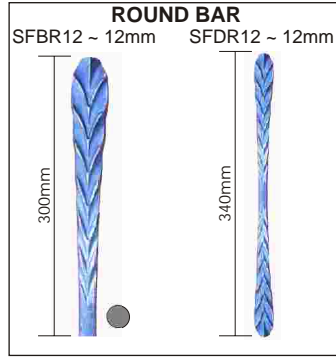
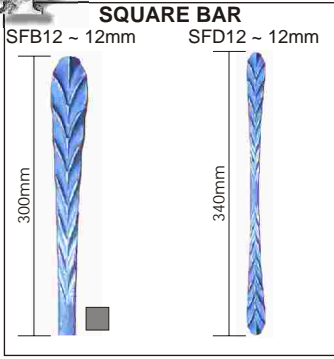

Reproduction Prohibited

**IMPORTANT**

IMAGES ARE ILLUSTRATIVE ONLY, ALL SIZES APPROXIMATE AS VARIATIONS MAY OCCUR.  
SEE REFERENCE PAGE.

# RAILHEAD

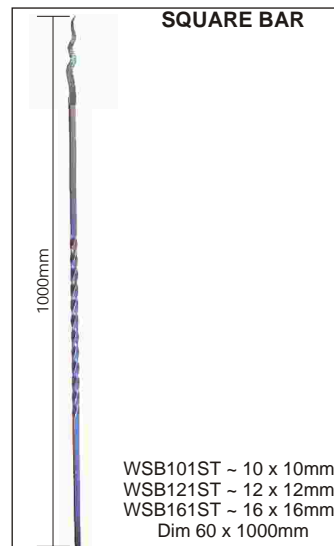
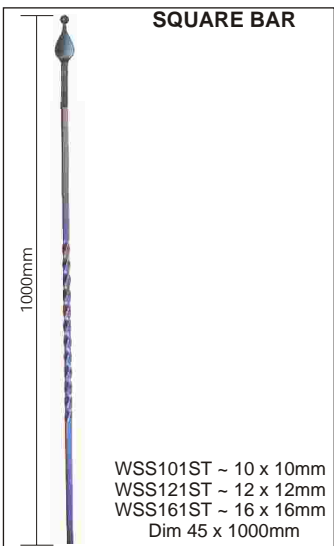
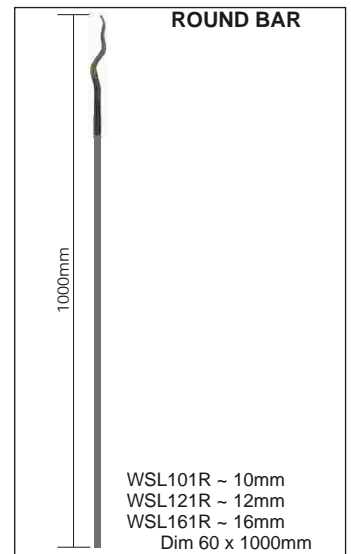
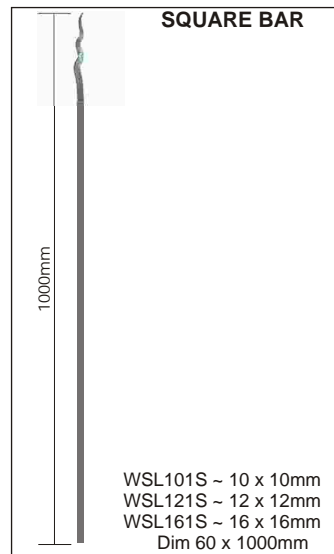
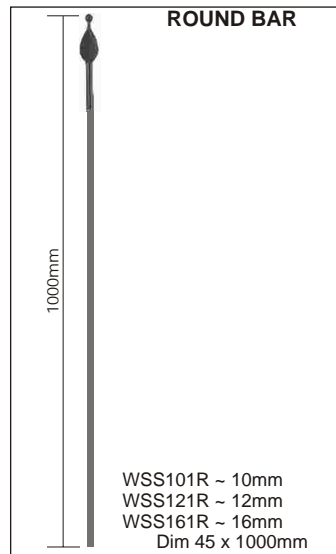
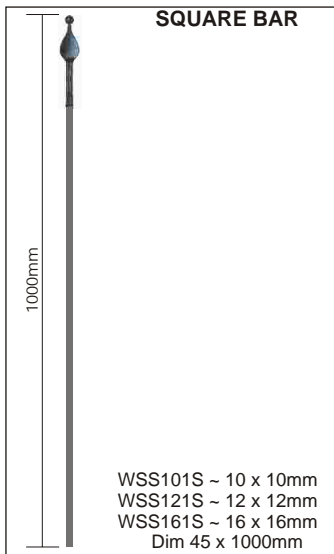
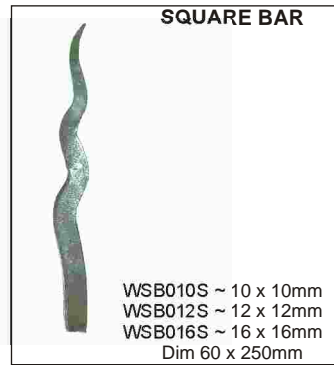
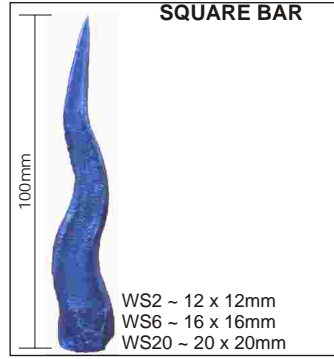
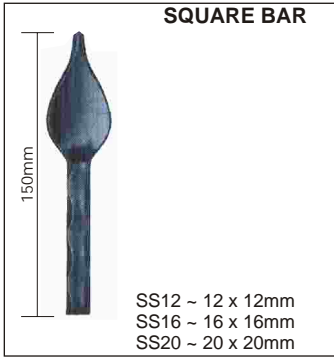

**IMPORTANT**  
IMAGES ARE ILLUSTRATIVE ONLY, ALL SIZES APPROXIMATE AS VARIATIONS MAY OCCUR.  
SEE REFERENCE PAGE.